



BACKPACK

TRUCK TOOL BOXES



Our History



1946
Buyers Products Company founded by Sam Ruven and Bessie Kleinman as a distributor of driveline components.

Tracom

1992
Buyers acquired Trailer Components Manufacturing (Tracom) for CNC precision machining and tooling, as well as state-of-the-art welding.

Buyers
PRODUCTS COMPANY

2002
Buyers moved its corporate headquarters to a brand new 235,000 sq. ft. state-of-the-art office and distribution center.

SnowDog
Buyers

2007
Buyers began manufacturing the SnowDog stainless steel snowplow at our Mentor, Ohio facility.

Buyers
PRODUCTS COMPANY

2013
Buyers acquired an additional 500,000 sq.ft. manufacturing facility in Mentor, Ohio allowing for expansion of our aluminum and stainless steel manufacturing.

SaltDog
Buyers

**ALL YOUR WORK
TRUCK PRODUCTS
ALL THE TIME.**

2017
Buyers launches new website with business partner portal, to make online ordering and account maintenance easy for customers.

Buyers

Buyers continued to grow its product offerings and build valued relationships with customers and suppliers. Increased demand for products led to the pursuit of supply chain manufacturing solutions.

PROGRESSIVE
POWDER COATING, INC.

1995
Buyers acquired Progressive Powder Coating. Our Nordson automatic powder application booth is used to powder coat our Buyers toolboxes and other truck and trailer accessories.

Romotech
Rotational Molding Technologies, Inc.

2004
Buyers acquired Romotech in New Paris, Indiana. Our Ferry Industries Rotospeed molding machines are used to manufacture our poly salt spreaders.

Boomerang
RUBBER, INC.

2009
Buyers began our operations at Boomerang Rubber, in Botkins, Ohio manufacturing mudflaps, wheel chocks and other rubber truck and trailer accessories.

Buyers
PRODUCTS COMPANY

2016
Buyers establishes a 22,000 sq ft Engineering Tech Center in Mentor, Ohio. It's multi-use lab, design, training and prototyping space is dedicated to the research and development of innovative product.

Our Corporate Family of Companies



Founded in 1946, Buyers Products is a fully integrated manufacturer and a leader in the truck equipment industry. Our engineering, manufacturing and assembly operations take place in the USA, under the Buyers family of companies. **Buyers Products' mission is to improve our Customers' profitability and productivity while enhancing the quality of our products and services.**





BACKPACK TRUCK TOOL BOXES

Choosing a Backpack	4
Comparison Table	5
4 Doors	
Offset Floor	6-7
Flat Floor.....	8-9
2 Doors	
Offset Floor	10-11
Flat Floor.....	12-13
L-Packs	14-15
Underbodies.....	16-17
Accessories	18

NOTHING WORKS LIKE A DOGG®

NEW PRODUCTS:

**2 DOORS, OFFSET FLOOR,
CARBON STEEL, BLACK POWDER-COATED** *pg. 11*



**2 DOORS, FLAT FLOOR,
DIAMOND TREAD ALUMINUM** *pg. 13*



**2 DOORS, FLAT FLOOR,
CARBON STEEL, BLACK POWDER-COATED** *pg. 13*



**L-PACK, OFFSET FLOOR,
CARBON STEEL, WHITE POWDER-COATED** *pg. 15*



Choose a style ...

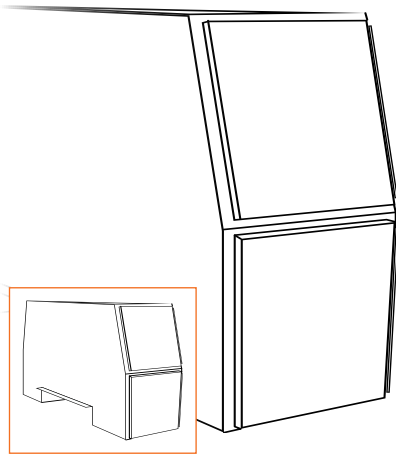

4 DOORS, SLANTED DOOR

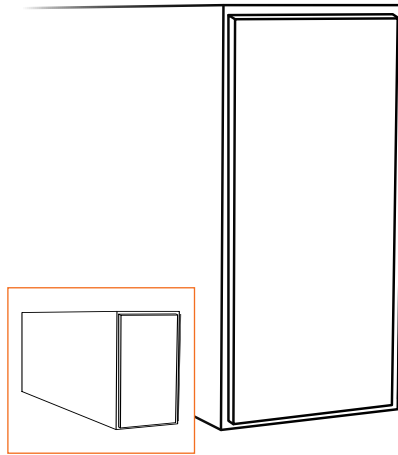

2 DOORS, STRAIGHT SIDES

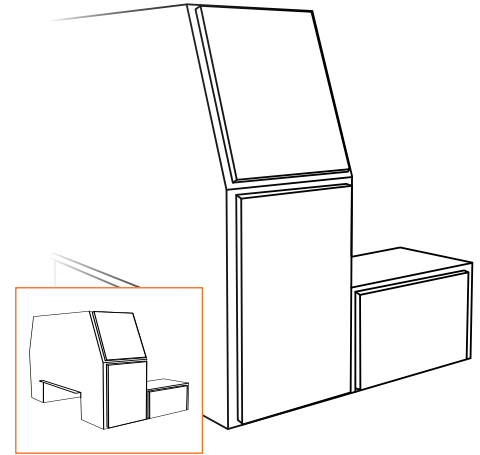

L-PACK

Choose a floor ...

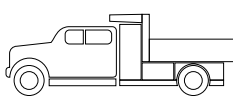
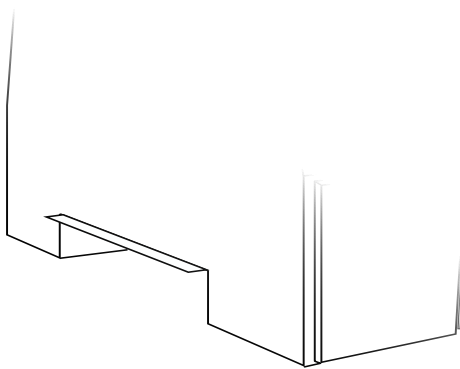

OFFSET FLOOR
(for conventional cabs)

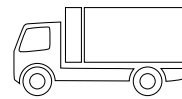
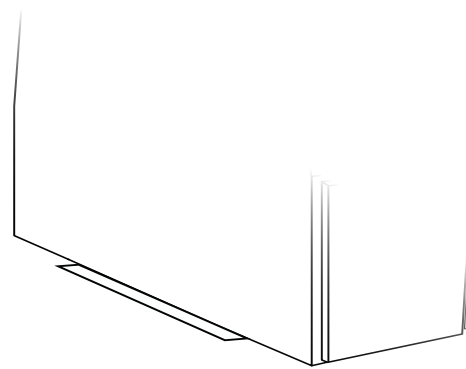

FLAT FLOOR
(for cab-over trucks)

Choose a material ...

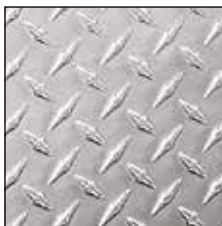

DIAMOND TREAD
ALUMINUM

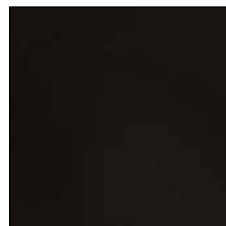

CARBON STEEL
BLACK



CARBON STEEL
WHITE

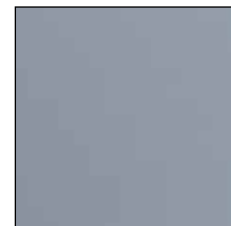

CARBON STEEL
PRIMED

COMPARISON TABLE

4 DOORS, OFFSET FLOOR						
Part No.	Material	Finish	Height (in.)	Length (in.)	Width (in.)	Weight (lbs.)
BP825524	Aluminum		55	24	82	234
BP826224	Aluminum		62	24	82	254
BP826524*	Aluminum		65	24	82	316
BP827024	Aluminum		70	24	82	316
BP925824	Aluminum		58	24	92	255
BP855524B	Carbon Steel		55	24	85	538
BP826524B*	Carbon Steel		65	24	82	600
BP925824B	Carbon Steel		58	24	92	576
BP855524W	Carbon Steel		55	24	85	538
BP826524W*	Carbon Steel		65	24	82	600
BP925824W	Carbon Steel		58	24	92	576
BP826524P*	Carbon Steel		65	24	82	600
BP925824P	Carbon Steel		58	24	92	576
BP855524P	Carbon Steel		55	24	85	538
4 DOORS, FLAT FLOOR						
Part No.	Material	Finish	Height (in.)	Depth (in.)	Width (in.)	Weight (lbs.)
BP824624	Aluminum		46	24	82	216
BP855924	Aluminum		59	24	85	350
BP824624B	Carbon Steel		46	24	82	454
BP855924B	Carbon Steel		59	24	85	536
BP824624W	Carbon Steel		46	24	82	454
BP855924W	Carbon Steel		59	24	85	536
BP824624P	Carbon Steel		46	24	82	454
BP855924P	Carbon Steel		59	24	85	536
2 DOORS, OFFSET FLOOR						
Part No.	Material	Finish	Height (in.)	Depth (in.)	Width (in.)	Weight (lbs.)
BP965724*	Aluminum		57	24	96	262
BP965724B*	Carbon Steel		57	24	96	690
BP965724W*	Carbon Steel		57	24	96	690
2 DOORS, FLAT FLOOR						
Part No.	Material	Finish	Height (in.)	Depth (in.)	Width (in.)	Weight (lbs.)
BP964824*	Aluminum		48	24	96	240
BP964824B	Carbon Steel		48	24	96	700
BP964824BLL	Carbon Steel		48	24	96	700
BP964824WLL	Carbon Steel		48	24	96	700
BP964824W	Carbon Steel		48	24	96	700
BP964824P	Carbon Steel		48	24	96	700
L-PACK						
Part No.	Material	Finish	Total Height (in.)	Depth (in.)	Width (in.)	Weight (lbs.)
BP826254	Aluminum		62	54	82	340
BP827054*	Aluminum		70	54	82	384
BP855548B*	Carbon Steel		55	48	85	638
BP855548W*	Carbon Steel		55	48	85	638

4 Doors, Offset Floor

DIAMOND TREAD ALUMINUM



- .100" thick aluminum diamond tread
- Universal spring cushion mounting kit, included with all aluminum backpack boxes, provides flex to reduce strain

CARBON STEEL



- 14 gauge steel box with 12 gauge steel doors
- Optional U-Bolt mounting kit sold separately (see page 18)

COMMON FEATURES



Manufactured by a talented workforce in Northeast Ohio

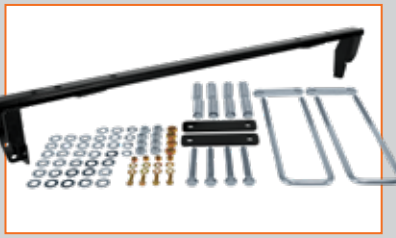

Backpack mounting adapter recommended for all 2017+ Ford® applications (see page 18 for details)



Stainless steel bolt-on continuous hidden hinges

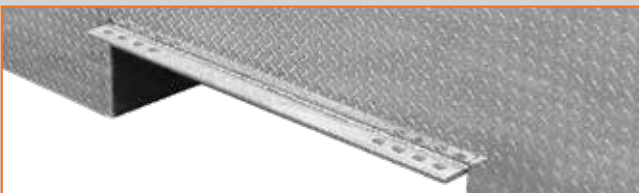

Integral mounting rail for quick and easy installation



Doors open easily with gas powered shocks
Built-in rain gutter with automotive bulb seal



Two shelves to organize tools and equipment
Two folding passenger side J-hooks

DIAMOND TREAD ALUMINUM

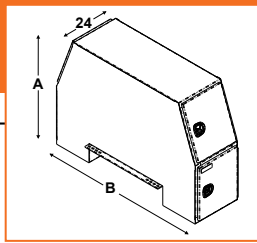

BP825524

Part No.	Total Height (A)	Depth	Width (B)	Wt. (lb)	Cat.
BP825524	55	24	82	234	592 (Y)
BP826224	62	24	82	254	592 (Y)
BP826524*	65	24	82	316	592 (Y)
BP827024	70	24	82	316	592 (Y)
BP925824	58	24	92	255	592 (Y)

CAUTION: Failure to use supplied mounting kit may void warranty on Aluminum Backpack Boxes



For optional underbody box, see pages 16-17.

CARBON STEEL, BLACK POWDER-COATED



BP855524B

Part No.	Total Height (A)	Depth	Width (B)	Wt. (lb)	Cat.
BP855524B	55	24	85	536	592 (Y)
BP826524B*	65	24	82	600	592 (Y)
BP925824B*	58	24	92	576	592 (Y)



For optional underbody box, see pages 16-17.

CARBON STEEL, WHITE POWDER-COATED



BP855524W

Part No.	Total Height (A)	Depth	Width (B)	Wt. (lb)	Cat.
BP855524W	55	24	85	538	592 (Y)
BP826524W*	65	24	82	600	592 (Y)
BP925824W*	58	24	92	576	592 (Y)



For optional underbody box, see pages 16-17.

CARBON STEEL, PRIMED POWDER-COATED



BP855524P

Part No.	Total Height (A)	Depth	Width (B)	Wt. (lb)	Cat.
BP855524P	55	24	85	538	592 (Y)
BP826524P*	65	24	82	538	592 (Y)
BP925824P*	58	24	92	576	592 (Y)



For optional underbody box, see pages 16-17.

4 Doors, Flat Floor

DIAMOND TREAD ALUMINUM



- .100" thick aluminum diamond tread
- Universal spring cushion mounting kit, included with all aluminum backpack boxes, provides flex to reduce strain

CARBON STEEL



- 14 gauge steel box with 12 gauge steel doors
- Optional U-Bolt mounting kit sold separately (see page 18)

COMMON FEATURES



Manufactured by a talented workforce in Northeast Ohio

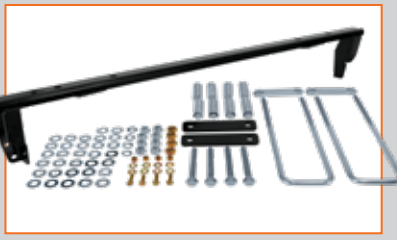

Backpack mounting adapter recommended for all 2017+ Ford® applications (see page 18 for details)



Stainless steel bolt-on continuous hidden hinges



Integral mounting rail for quick and easy installation



Doors open easily with gas powered shocks
Built-in rain gutter with automotive bulb seal



Two shelves to organize tools and equipment
Two folding passenger side J-hooks

DIAMOND TREAD ALUMINUM



BP825524

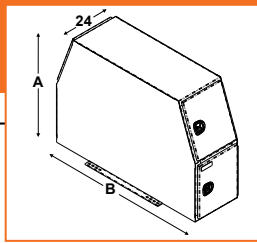

Part No.	Total Height (A)	Depth	Width (B)	Wt. (lb)	Cat.
BP824624	46	24	82	216	592 (Y)
BP855924	59	24	85	350	530 (Y)



For optional underbody box, see pages 16-17.

CAUTION: Failure to use supplied mounting kit may void warranty on Aluminum Backpack Boxes

STEEL, BLACK POWDER-COATED



BP824624B



Part No.	Total Height (A)	Depth	Width (B)	Wt. (lb)	Cat.
BP824624B	46	24	82	454	592 (Y)
BP855924B	59	24	85	536	592 (Y)



For optional underbody box, see pages 16-17.

STEEL, WHITE POWDER-COATED



BP855924W



Part No.	Total Height (A)	Depth	Width (B)	Wt. (lb)	Cat.
BP824624W	46	24	81	454	592 (Y)
BP855924W	59	24	85	536	592 (Y)



For optional underbody box, see pages 16-17.

STEEL, PRIMED POWDER-COATED



BP855924P



Part No.	Total Height (A)	Depth	Width (B)	Wt. (lb)	Cat.
BP824624P	46	24	81	454	592 (Y)
BP855924P	59	24	85	536	592 (Y)



For optional underbody box, see pages 16-17.

2 Doors, Offset Floor

DIAMOND TREAD ALUMINUM



- .100" thick aluminum diamond tread
- Universal spring cushion mounting kit, included with all aluminum backpack boxes, provides flex to reduce strain

CARBON STEEL



- 14 gauge steel box with 12 gauge steel doors
- Optional U-Bolt mounting kit sold separately (see page 18)

COMMON FEATURES



Manufactured by a talented workforce in Northeast Ohio

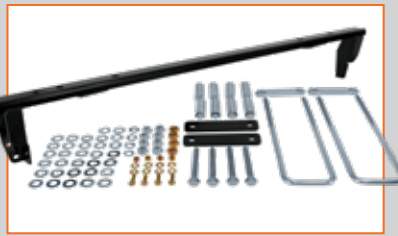

Backpack mounting adapter recommended for all 2017+ Ford® applications (see page 18 for details)



Stainless steel bolt-on continuous hidden hinges

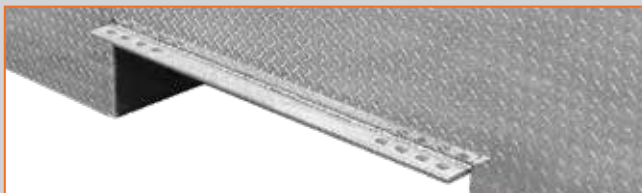

Integral mounting rail for quick and easy installation



Doors open easily with gas powered shocks
Built-in rain gutter with automotive bulb seal

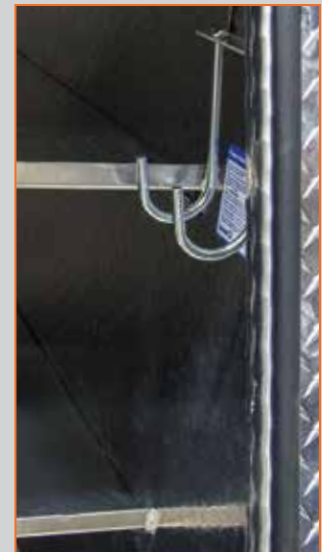

Two shelves to organize tools and equipment
Two folding passenger side J-hooks

DIAMOND TREAD ALUMINUM



BP965724

Part No.	Total Height	Depth	Width	Wt. (lb)	Cat.
BP965724*	57	24	96	262	592 (Y)



For optional underbody box, see pages 16-17.

****CAUTION:** Failure to use supplied mounting kit may void warranty on Aluminum Backpack Boxes

STEEL, BLACK POWDER-COATED



BP965724B

Part No.	Total Height	Depth	Width	Wt. (lb)	Cat.
BP965724B*	57	24	96	690	592 (Y)



For optional underbody box, see pages 16-17.

STEEL, WHITE POWDER-COATED



BP965724W

Part No.	Total Height	Depth	Width	Wt. (lb)	Cat.
BP965724W*	57	24	96	690	592 (Y)



For optional underbody box, see pages 16-17.

2 Doors, Flat Floor

DIAMOND TREAD ALUMINUM



- .100" thick aluminum diamond tread
- Universal spring cushion mounting kit, included with all aluminum backpack boxes, provides flex to reduce strain

CARBON STEEL



- 14 gauge steel box with 12 gauge steel doors
- Optional U-Bolt mounting kit sold separately (see page 18)

COMMON FEATURES



Manufactured by a talented workforce in Northeast Ohio

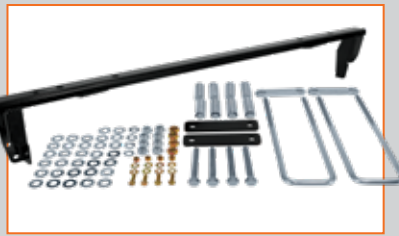

Backpack mounting adapter recommended for all 2017+ Ford® applications (see page 18 for details)



Stainless steel bolt-on continuous hidden hinges



Integral mounting rail for quick and easy installation



Doors open easily with gas powered shocks
Built-in rain gutter with automotive bulb seal

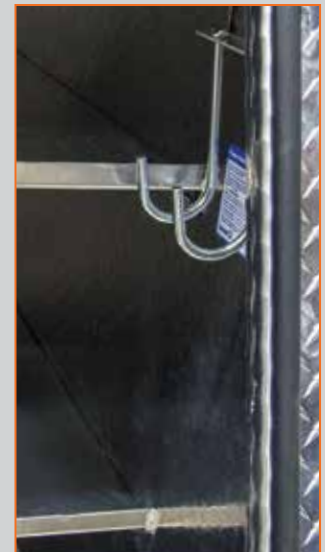

Two shelves to organize tools and equipment
Two folding passenger side J-hooks

DIAMOND TREAD ALUMINUM



BP964824

Part No.	Total Height	Depth	Width	Wt. (lb)	Cat.
BP964824*	48	24	96	240	592 (Y)



For optional underbody box, see pages 16-17.

****CAUTION:** Failure to use supplied mounting kit may void warranty on Aluminum Backpack Boxes

STEEL, BLACK POWDER-COATED



BP964824B



Part No.	Total Height	Depth	Width	Wt. (lb)	Cat.
BP964824B*	48	24	96	700	592 (Y)
BP964824BLL*	48	24	96	700	592 (Y)

BP964824BLL comes with 2 full length adjustable shelves



For optional underbody box, see pages 16-17.

STEEL, WHITE POWDER-COATED



BP964824W



Part No.	Total Height	Depth	Width	Wt. (lb)	Cat.
BP964824W*	48	24	96	700	592 (Y)
BP964824WLL*	48	24	96	700	592 (Y)

BP964824WLL comes with 2 full length adjustable shelves



For optional underbody box, see pages 16-17.

STEEL, PRIMED POWDER-COATED



BP964824P

Part No.	Total Height	Depth	Width	Wt. (lb)	Cat.
BP964824P*	48	24	96	700	592 (Y)



For optional underbody box, see pages 16-17.

L-Pack

DIAMOND TREAD ALUMINUM

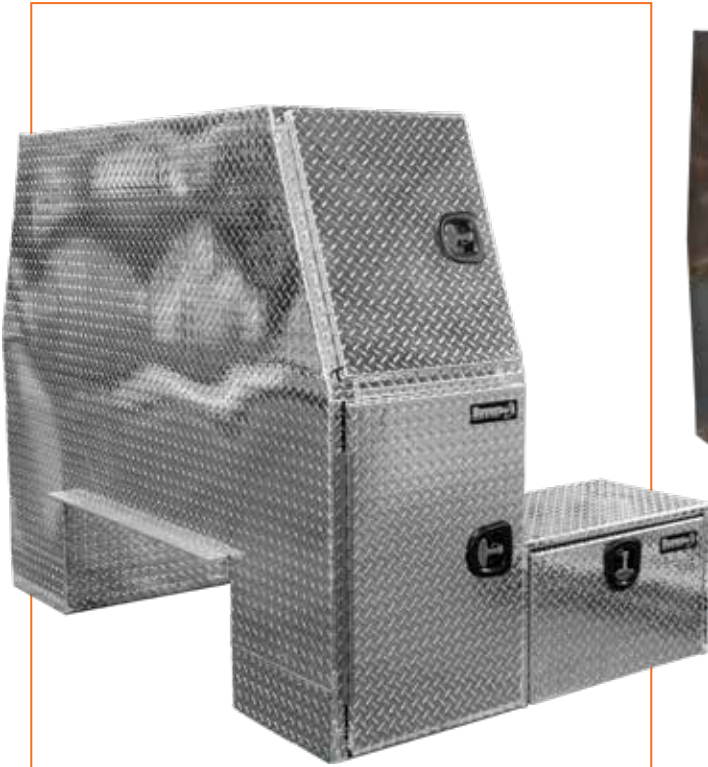

- .100" thick aluminum diamond tread
- Ships with 2 additional 30" underbody boxes welded on to provide additional storage
- Universal spring cushion mounting kit, included with all aluminum backpack boxes, provides flex to reduce strain

CARBON STEEL



- Tough 14 gauge steel body and 12 gauge steel doors with a corrosion resistant powder-coated finish
- Ships with 2 additional 24" underbody boxes bolted on to provide additional storage
- Optional U-Bolt mounting kit sold separately (see page 18)

COMMON FEATURES



Manufactured by a talented workforce in Northeast Ohio

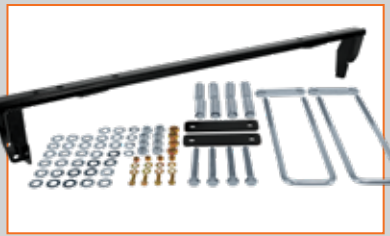

Backpack mounting adapter recommended for all 2017+ Ford® applications (see page 18 for details)



Stainless steel bolt-on continuous hidden hinges

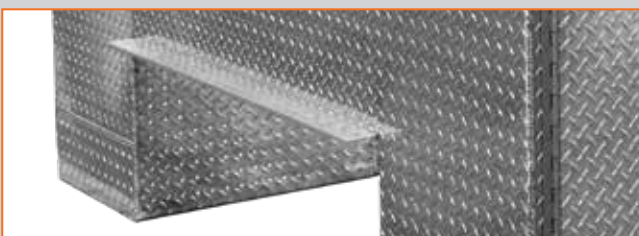

Integral mounting rail for quick and easy installation



Doors open easily with gas powered shocks
Built-in rain gutter with automotive bulb seal

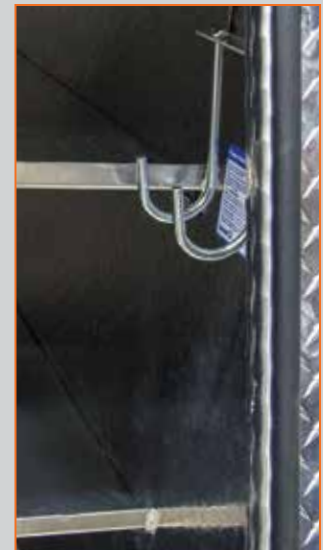

Two shelves to organize tools and equipment
Two folding passenger side J-hooks

DIAMOND TREAD ALUMINUM

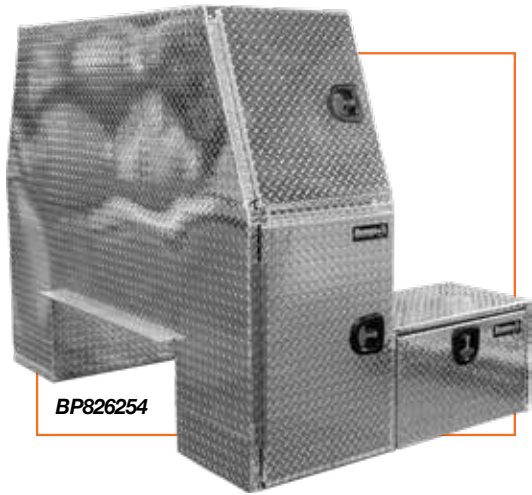

BP826254

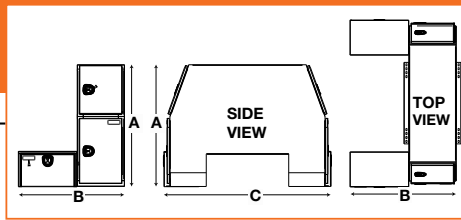

Spring Cushion Mounting Kit**



Locking Compression Latch



Part No.	Total Height (A)	Depth (C)	Width (B)	Wt. (lb)	Cat.
BP826254	62	54	82	340	592 (Y)
BP827054*	70	54	82	384	592 (Y)

CAUTION: Failure to use supplied mounting kit may void warranty on Aluminum Backpack Boxes

STEEL, BLACK POWDER-COATED



BP855548B

Locking T-Handle Latch



Part No.	Total Height (A)	Depth (C)	Width (B)	Wt. (lb)	Cat.
BP855548B*	55	54	82	638	592 (Y)

STEEL, WHITE POWDER-COATED



BP855548W

Locking T-Handle Latch



Part No.	Total Height (A)	Depth (C)	Width (B)	Wt. (lb)	Cat.
BP855548W*	55	54	82	638	592 (Y)

Underbody Boxes

DIAMOND TREAD ALUMINUM



- Can be used as bolt-on or weld-on underbodies with any backpack box
- Durable, corrosion-resistant, .100" thick aluminum diamond tread
- Locking die-cast T-handle compression latch

CARBON STEEL



- Can be used as bolt-on underbodies with any backpack box
- 14 gauge powder-coated steel box with 12 gauge steel door
- Locking stainless steel T-handle latch

COMMON FEATURES



Manufactured by a talented workforce in Northeast Ohio



Drop-down recessed door



Aluminum bolt-on continuous hidden hinge and replaceable gasket sealing system

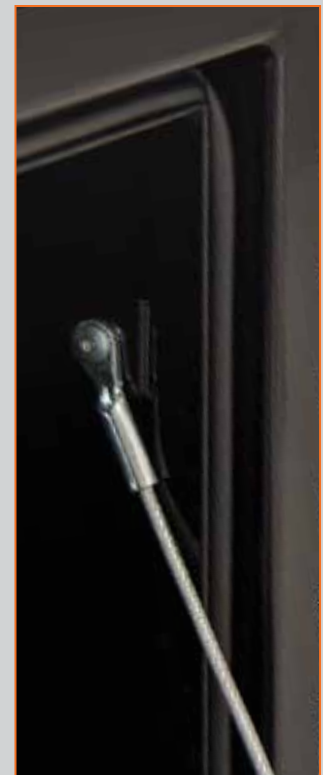

Aircraft grade door cables

DIAMOND TREAD ALUMINUM

Locking
Compression Latch



BP141624

Part No.	Total Height	Depth	Width	Wt. (lb)	Cat.
BP141624	14	16	24	18	530

STEEL, BLACK POWDER-COATED

Locking
T-Handle Latch



1703300

Part No.	Total Height	Depth	Width	Wt. (lb)	Cat.
1703300	14	16	25	46	530
1703303	14	16	30	55	530
1703304*	14	16	30	72	530

*Includes built-in shelf

STEEL, WHITE POWDER-COATED

Locking
T-Handle Latch



1703400

Part No.	Total Height	Depth	Width	Wt. (lb)	Cat.
1703400	14	16	24	46	530
1703403	14	16	30	55	530
1703404*	14	16	30	72	530

*Includes built-in shelf

STEEL, PRIMED POWDER-COATED

Locking
T-Handle Latch



1703900

Part No.	Total Height	Depth	Width	Wt. (lb)	Cat.
1703900	14	16	24	46	530

Backpack Accessories

STEEL AND ALUMINUM BACKPACK ACCESSORIES

Universal Spring Cushion Mounting Kit

- Provides flex to reduce strain on steel and aluminum backpack truck boxes
- Ideal for off-road applications
- 5/8" U-bolts with forged tie bars, springs and fasteners (all zinc plated)
- Included with all aluminum backpacks

- ⚠ **CAUTION:** Failure to use supplied mounting kit may void warranty on aluminum backpack boxes
- Additional sizes available as custom orders

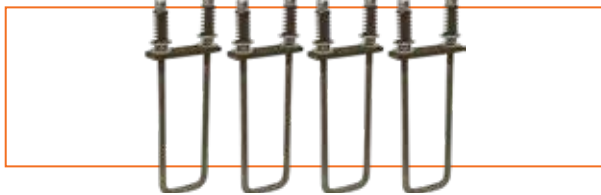

Part No.	Description	Wt. (lb)	Cat.
3008086	Universal Spring Cushion Mounting Kit	17	531 (Y)

Universal Square Bend U-Bolt Kit

- Secure truck boxes to truck body, or connect body to truck chassis
- 5/8" U-Bolts with fasteners and forged tie bars
- Durable Grade 5 hardware
- Additional sizes available as custom orders

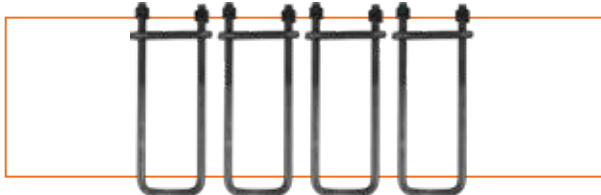

Part No.	Description	Wt. (lb)	Cat.
UB623516	Universal Mounting Kit	17	531 (Y)

Backpack Mounting Adapter

- Provides a level base with a pre-fabricated kit that ensures optimal fit and reduced installation time
- Black powder-coated bracket and zinc plated hardware add corrosion resistance
- Recommended for use with all Ford® 2017+ applications

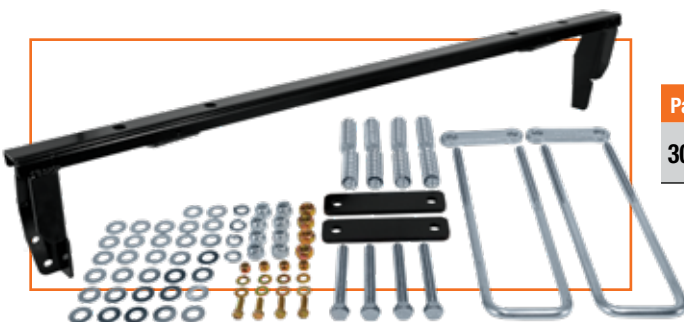

Part No.	Description	Wt. (lb)	Cat.
3037014	Backpack Mounting Adapter for Ford 2017+	47.24	531 (Y)

J-Hook Hanger

- Universal J-hook hangers for holding items like chains or straps
- Bolt-on or weld-on
- Folding zinc plated J-hooks swing flush with compartment walls when not in use
- Hanger 3009122 comes installed inside every box*



*Excludes BP964824BLL and BP964824WLL due to full-length shelving.

Part No.	Description	Wt. (lb)	Cat.
3009122	Double J-Hook with Steel Mounting Angle	0.85	530-1 (N)
3009938	Triple J-Hook with Aluminum Mounting Angle	2.16	530-1 (N)

LED Strip Light with 3M[®]** Adhesive Back



- Flexible strip lights can be mounted nearly anywhere extra light is needed. Ideal for tool boxes, truck beds, storage boxes, and trunk areas
- Each strip has a blunt cut connection on both ends and can be cut to length every three LEDs
- IP67 rated for water and dust resistance and backed with a 5 year warranty
- Includes end caps and mounting clips
- Separate 17.5" mounting channel also available

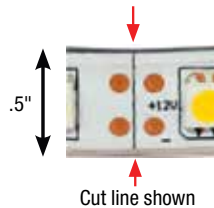

Part No.	Size	LED's	Amps	Lumens	Color	Connection	Std. Qty.	Wt. (lbs.)	Cat.
5621827	18"	27	0.41	360	Clear, Warm	Blunt Cut, Both Ends	1	0.31	562 (N)
5621928	18"	27	0.41	360	Clear, Cool	Blunt Cut, Both Ends	1	0.31	562 (N)
5622436	24"	36	0.54	470	Clear, Warm	Blunt Cut, Both Ends	1	0.35	562 (N)
5622537	24"	36	0.54	470	Clear, Cool	Blunt Cut, Both Ends	1	0.35	562 (N)
5623654	36"	54	0.81	710	Clear, Warm	Blunt Cut, Both Ends	1	0.40	562 (N)
5623755	36"	54	0.81	710	Clear, Cool	Blunt Cut, Both Ends	1	0.40	562 (N)
5624872	48"	72	1.12	940	Clear, Warm	Blunt Cut, Both Ends	1	0.44	562 (N)
5624973	48"	72	1.12	940	Clear, Cool	Blunt Cut, Both Ends	1	0.44	562 (N)
5626090	60"	90	1.30	1180	Clear, Warm	Blunt Cut, Both Ends	1	0.55	562 (N)
5626191	60"	90	1.30	1175	Clear, Cool	Blunt Cut, Both Ends	1	0.55	562 (N)
56296144	96"	144	2.00	2160	Clear, Warm	Blunt Cut, Both Ends	1	0.88	562 (N)
56297145	96"	144	2.00	2160	Clear, Cool	Blunt Cut, Both Ends	1	0.88	562 (N)
562109166	108"	165	3.00	2400	Clear, Cool	Blunt Cut, Both Ends	1	1.12	562 (N)
562133202	132"	201	4.00	3000	Clear, Cool	Blunt Cut, Both Ends	1	1.37	562 (N)

LED Strip Light Mounting Channel



3035896 shown with cool temperature strip

Part No.	Length	Color	Mounting	Cat.
3035896	17-1/2"	Black	3M [®] ** Tape	562 (N)

**3M[®] is a registered trademark of 3M Company

The Buyers family of manufacturing companies

Tracom

B **Boomerang**
RUBBER, INC.

Romotech
Rotational Molding Technologies, Inc.

P **PROGRESSIVE**
POWDER COATING, INC.



www.buyersproducts.com

Buyers
PRODUCTS COMPANY 

SnowDogg 
by Buyers

SaltDogg 
by Buyers

ScoopDogg 
by Buyers

DumperDogg 
by Buyers

BACKPACK_SUP